

DISTRIBUTED BY
QBM
QUALITY BUILDING MATERIALS



vestis

RAINWATER SYSTEM



 **mazzonetto**



INDEX

Description	05
Advantages	07
Standing seam roofing system	11
Double standing seam	13
Angled standing seam	15
The Skin Air 450 / The Skin Clips	18
Roofing Accessories / Ventilated Ridge	19
Roofing accessories	20

DESCRIPTION

Vestis is Mazzone's pre-painted aluminium.

Aluminium has a lightweight, corrosionproof and ductile nature; these three characteristics make it the material of the future. It meets perfectly the modern requirements of the building industry without thwarting the creativity of the designers. As a brand, Vestis distinguishes itself for its toughness. It can be used in the most hostile environments where it will resist ageing and withstand UV rays, even at high altitudes and in coastal locations.

The creative vein of the designers is gratified by a wide range of different colors and surfaces which can be either smooth or textured, as per the latest cladding trends. Mazzone has developed a complete rainwater system line, in order to provide a safe solution which consistently reduces the risk for water and moisture damage on facades, plinths and foundations, always considering a pleasant aesthetic appearance, in the respect of high quality standards.



Vestis Graphite Black



Vestis Ral 7037

TECHNICAL CHARACTERISTICS

COATING FINISH	EXTERNAL ENVIRONMENTAL CONDITIONS					
	RURAL	URBAN/ INDUSTRIAL (moderate pollution)	INDUSTRIAL (severe pollution)	MARINE (>3 km)	MARINE (3 km > 1 km)	STRONG UV RAYS (over 900 m altitude)
VESTIS	40 Year Warranty	40 Year Warranty	20 Year Warranty	40 Year Warranty	20 Year Warranty	40 Year Warranty

DENSITY	2,70 kg/dm
BASE METAL - VESTIS LINE FOR PROFILES AND FACADE CLADDING	H41
ALLOY TYPE	Serie 3005
THERMAL EXPANSION COEFFICIENT	0,023 $\frac{\text{mm}}{\text{m}^\circ\text{C}}$
FIRE REACTION CLASS	A1
SURFACE PENCIL HARDNESS	H
CRACK FORMATION DURING BENDING	≤ 1,5T free of cracks
ADHESION AFTER BENDING	≤ 1T peel adhesion

ADVANTAGES

1 - LIGHTWEIGHT

Aluminium roof weight is around 2 kg/m². This is 1/10 of a traditional tile roof and less than half of a copper, titanium zinc and prepainted steel roof.

Lightness is an advantage for the installer while working on the roof and with rainwater system too. In renovating old houses it is not necessary to reinforce the old roof understructure saving money and time.

2 - MALLEABLE & EASY TO WORK WITH

Aluminium alloy is very flexible and ductile.

VESTIS H41 hardness is the ideal metal to be used in double standing seam installations. Moreover it can be worked without breakage at low temperature.

3 - LONG TIME RESISTANT:

RUSTPROOF: aluminium protects itself from rust with a self-protective layer.

SEVERE ATMOSPHERICAL CONDITIONS RESISTANT: with 35 microns of high durability polyester coating on the front face, the material is very well protected by storms, snow and strong UV rays too. Indeed Vestis is warranted even if installed over 900 m of altitude.

20 microns of polyester on the back face ensure gutters longer life, while roof and facade are protected from the contact with other materials.

4 - DESIGN & CREATIVITY

Aluminium ductility gives the opportunity to create any shape without limitation to the architectural creativity. It can be combined with traditional and modern buildings, according to everyone's preferences.

5 - COMPLETE LINE

VESTIS is presented with a complete line of roofing accessories and rainwater system.

6 - ECOLOGICAL & RECYCLABLE

Aluminium is 100% recyclable and atoxic.

7 - WARRANTY

VESTIS is covered by a 40 year warranty against corrosion and color ageing for a long-lasting life. Warranty is automatic and it covers both coils and rainwater system.

COLORS AND FINISHINGS

K2 ROOF SURFACES



COPPER ROOF

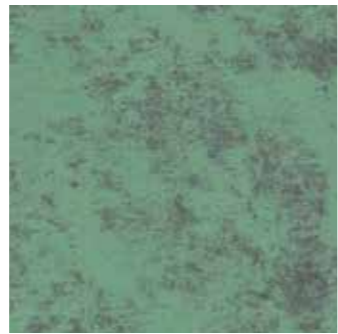

GREEN ROOF



GREY ROOF

K2 SMOOTH SURFACES

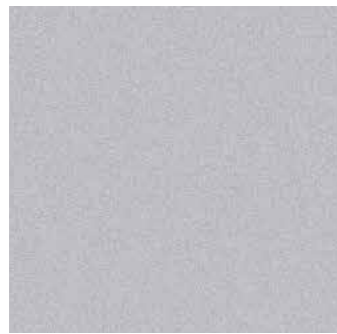

RAL 9006

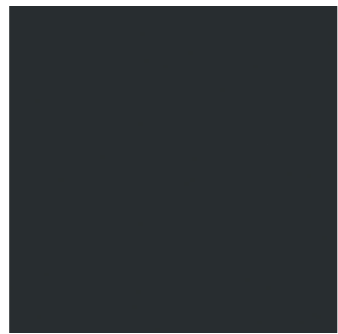

RAL 7016



RAL 7037

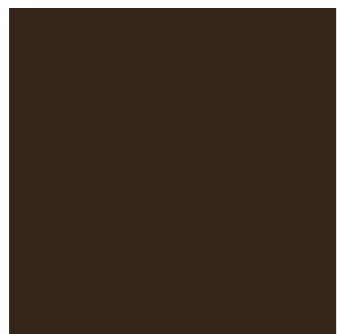

TESTA DI MORO

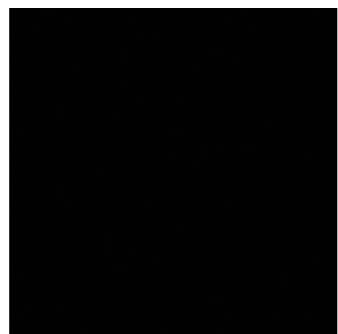

RAL 9005

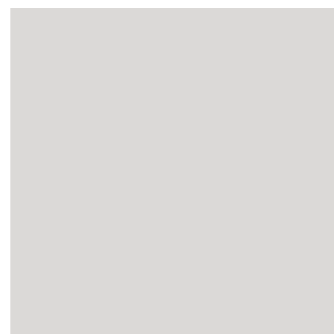

RAL 9010

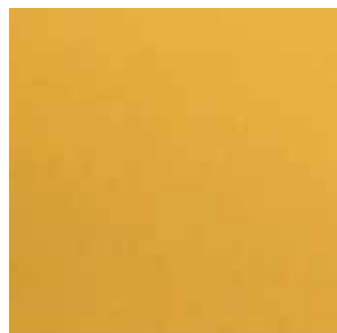

GOLD

COLORS AND FINISHINGS

K2 MATT SURFACES



GRAPHITE BLACK



AGATE GREY



SLATE GREY

3D TEXTURED SURFACES



RAL 7016

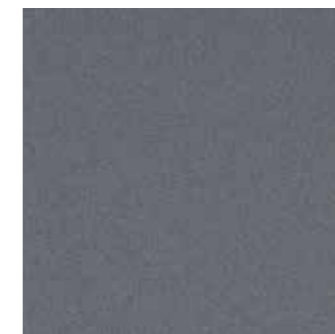

RAL 7037



TESTA DI MORO



DOLOMITES GREY



CORTEX

The colors may show slight differences
in color tone between different production lots.



STANDING SEAM ROOFING SYSTEM

The seaming technique allows joining of previously profiled sheets and strips by overlapping them and folding over the edges. They are anchored to the substructure using not visible fixed and sliding clips fixed with screws. Thanks to its versatility, the standing seam technique is the most versatile solution for the most complex shapes.

Use

Roof and facade

Minimum slope

3°

Laying surface

25 mm thick OSB panels – CLASS 3

Raw fir wooden boards sec. 100 mm X 25 mm

Seam height

24 mm

Widths

Standard profile interax according to the metal 430/580 mm

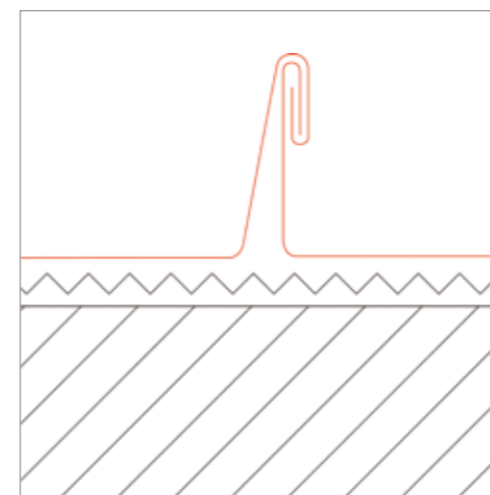

Double standing seam

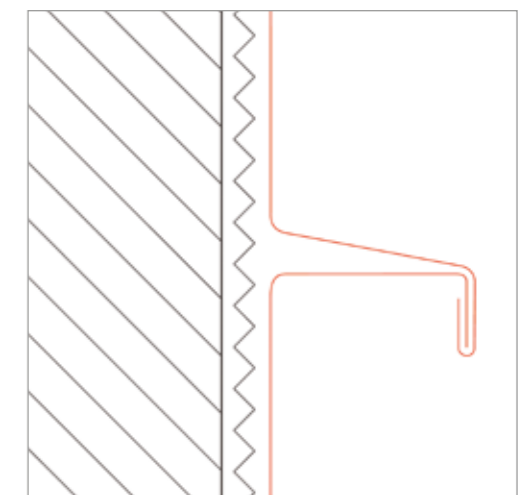

Angled standing seam



Vestis Ral 7016 3D

DOUBLE STANDING SEAM

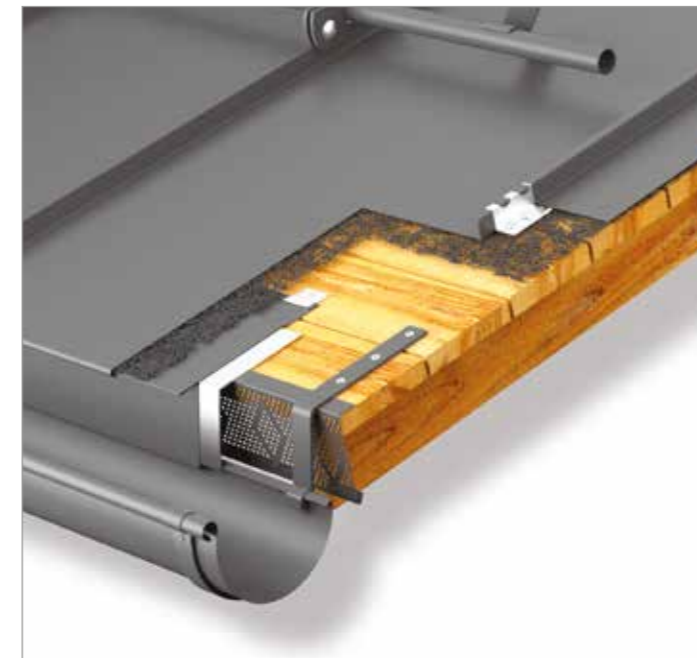
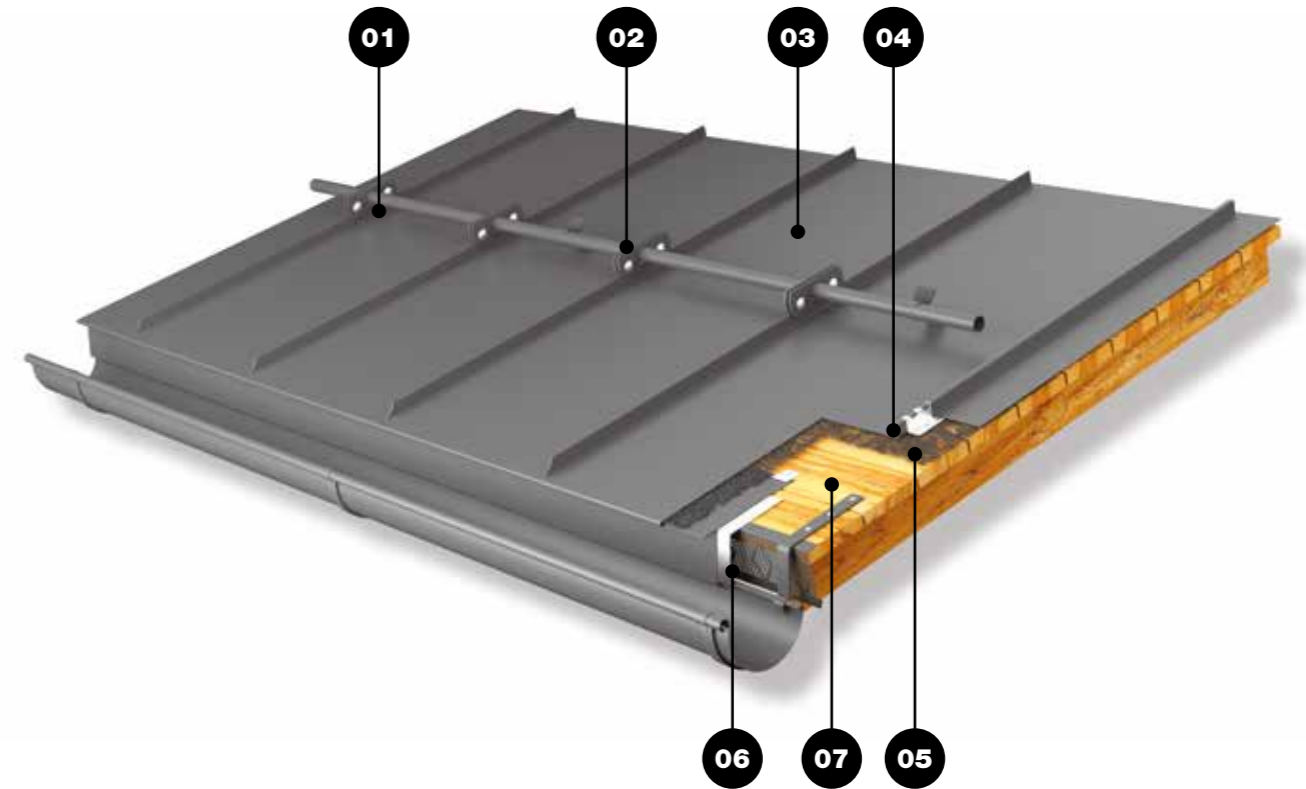

- 01** Snowguard pipe
- 02** Mounting clamps
- 03** Standing seam metal covering
- 04** The Skin hidden clips for indirect fixing
- 05** The Skin Air anti-condensation filament tridimensional mesh
- 06** Perforated strip
- 07** Planking

ANGLED STANDING SEAM

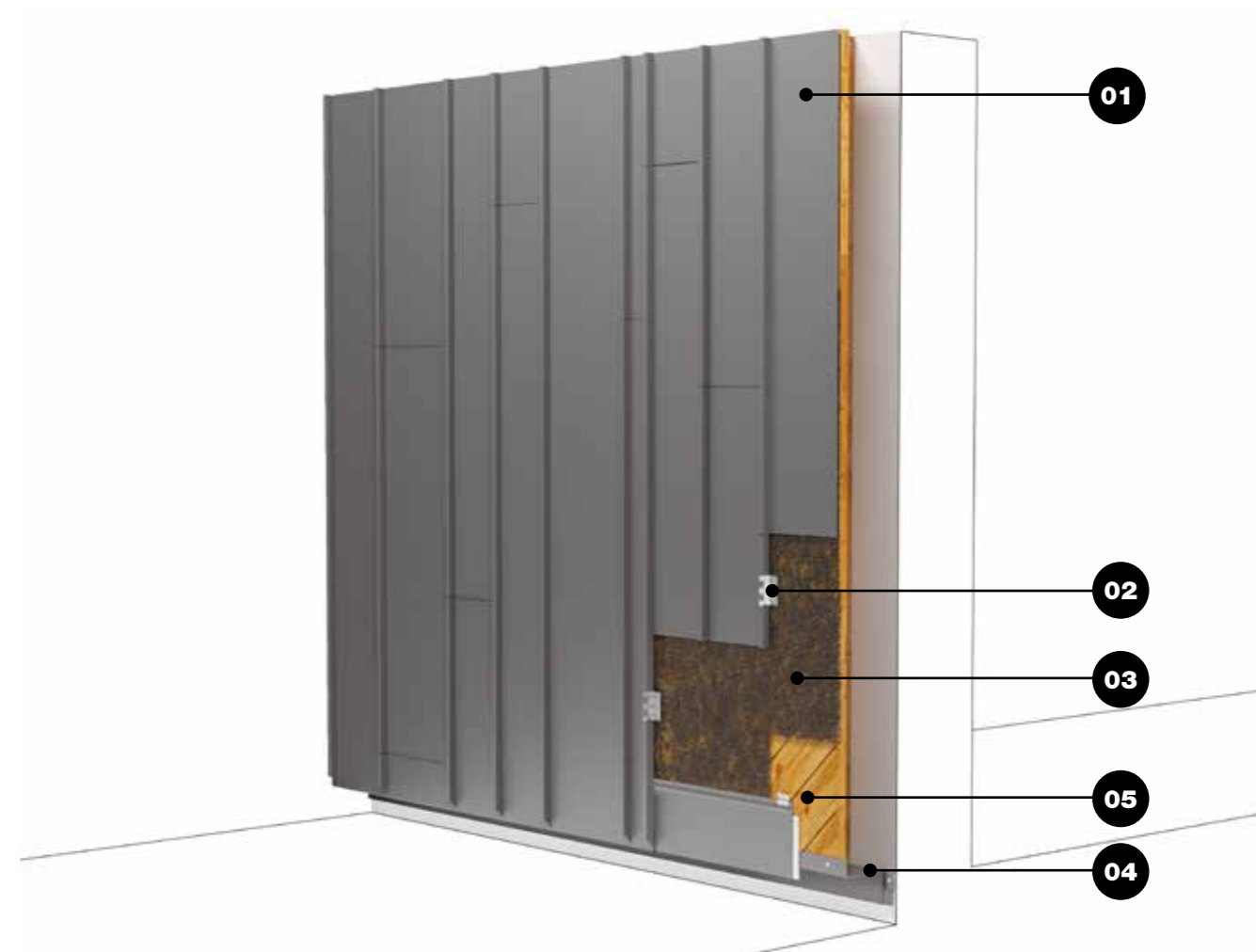

- 01 Standing seam metal covering
- 02 The Skin hidden clips for indirect fixing
- 03 The Skin air anti-condensation filament tridimensional mesh
- 04 Perforated strip
- 05 Planking



Vestis Graphite Black



Vestis Ral 7037 3D



Vestis Dolomites Grey 3D

THE SKIN AIR 450



THE SKIN AIR 450



THE SKIN AIR 450 WITH BREATHABLE MEMBRANE

Separating layer for the standing seam roofing system proposed by Mazzonetto, to be laid between the substructure and the Vestis material. The Skin Air ensures following performances:

An anti-vibration effect

It stops the diffusion of rain and hail noise by keeping the seamed metal in tension.

A micro-ventilation

It avoids condensation under the metal covering and assures high airflow.

A separating element

It lifts the metal in case of discontinuous layer or imperfections that could damage it.

The product is made of NON recycled polypropylene to ensure a lifetime similar to that of the metal. THE SKIN AIR 450 can be used also for ventilated facades on a continuous layer.

THE SKIN CLIPS



Advanced system for fixing folded profiles.

The SKIN CLIPS are available both fixed and sliding. Made of stainless steel, they allow an upward load resistance till 10 times higher than than the standard clips. Special ribs on the bottom side make the clips crashproof and protect the screw head, moreover they are designed to hook the dedicated screwdriver to an automatic screw loader.

The SKIN sliding clips allow the sliding of the profiles till 40 mm and assure the absence of noise, moreover their movement cannot be blocked by roofing accessories and mounting clamps.

ROOFING ACCESSORIES

The mounting clamps are made of prepainted aluminium in the same color of the metal covering. They are designed for the installation of snowguard pipes with a diameter of 28 mm, similarly colored.

They are available as 1 or 2 pipe mounting clamps.

The clamps are designed to be fixed to the metal covering without blocking the sliding clips, independently from the shape. All edges are rounded to avoid damaging the metal.

The clamps have been tested in laboratory to measure their performances. It is possible to calculate and verify the performance of the snowguard system on every roof.



VENTILATED RIDGE

The ventilated ridge of the Vestis system is distinguished by its high performances and for an easy installation. It consists of a kit including an element in galvanised steel to be fixed through dedicated screws to specific brackets. The bracket are made of 2mm thick galvanised steel and fit to any slope.

The ridge is designed to permit a quick air outlet and block the rain to come in even in case of extreme weather events.

The ridge is walkable, the metal covering is realized in the same metal and color of the roof and it is fixed to the structure in galvanised steel without direct fixings.



ROOFING ACCESSORIES







		TESTA DI MODO	RAL 7016	RAL 7037	RAL 9005	RAL 9006	RAL 9010	TESTA DI MODO 3D	RAL 7016 3D	RAL 7037 3D	CORTEX 3D	DOLOMITES GREY 3D	GRAPHITE BLACK	SLATE GREY	AGATE GREY	COPPER ROOF	GREEN ROOF	GREY ROOF	GOLD	
	COILS FOR DOUBLE STANDING SEAM – SMOOTH AND STUCCO SURFACE	1300x0,70 mm	●	●	●	●	●	●	●	●	●	●	●	●	●	●	●	●	●	●
	650x0,70 mm	●	●	●	●	●	●	●	●	●	●	●	●	●	●	●	●	●	●	●
	1000x0,70 mm	●	●	●	●	●	●	●	●	●	●	●	●	●	●	●	●	●	●	●
	500x0,70 mm	●	●	●	●	●	●	●	●	●	●	●	●	●	●	●	●	●	●	●
	MOUNTING CLAMPS FOR SNOWGUARD PIPES	●	●	●	●	●	●	●	●	●	●	●	●	●	●	●	●	●	●	●
	2 PIPE MOUNTING CLAMPS FOR SNOWGUARD PIPES	●	●	●	●	●	●	●	●	●	●	●	●	●	●	●	●	●	●	●
	SNOWGUARD PIPES Ø 28 mm	●	●	●	●	●	●	●	●	●	●	●	●	●	●	●	●	●	●	●
	JOINTS FOR SNOWGUARD PIPES Ø 28 mm	●	●	●	●	●	●	●	●	●	●	●	●	●	●	●	●	●	●	●
	ICEBREAKER Ø 28 mm	●	●	●	●	●	●	●	●	●	●	●	●	●	●	●	●	●	●	●

● IN STOCK

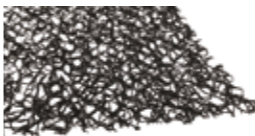

● ON REQUEST

○ ORDER OVER 300 SM

ROOFING ACCESSORIES

		TESTA DI MODO	RAL 7016	RAL 7037	RAL 9005	RAL 9006	RAL 9010	TESTA DI MODO 3D	RAL 7016 3D	RAL 7037 3D	CORTEX 3D	DOLOMITES GREY 3D	GRAPHITE BLACK	SLATE GREY	AGATE GREY	COPPER ROOF	GREEN ROOF	GREY ROOF	GOLD	
	MOUNTING CLAMPS FOR PHOTOVOLTAIC PANELS IN STAINLESS STEEL	●	●	●	●	●	●	●	●	●	●	●	●	●	●	●	●	●	●	●
	MOUNTING CLAMPS FOR SOLAR PANELS IN STAINLESS STEEL	●	●	●	●	●	●	●	●	●	●	●	●	●	●	●	●	●	●	●
	THE SKIN FIXED CLIPS H 32 mm - H 25 mm IN STAINLESS STEEL	●	●	●	●	●	●	●	●	●	●	●	●	●	●	●	●	●	●	●
	THE SKIN SLIDING CLIPS H 32 mm - H 25 mm IN STAINLESS STEEL	●	●	●	●	●	●	●	●	●	●	●	●	●	●	●	●	●	●	●
	THE SKIN AIR 450 FILAMENT ANTICONDENSATION TRIDIMENSIONAL MESH	●	●	●	●	●	●	●	●	●	●	●	●	●	●	●	●	●	●	●
	THE SKIN AIR 450 FILAMENT ANTICONDENSATION TRIDIMENSIONAL MESH WITH BREATHABLE MEMBRANE	●	●	●	●	●	●	●	●	●	●	●	●	●	●	●	●	●	●	●
	VENTILATED RIDGE IN GALVANISED STEEL	●	●	●	●	●	●	●	●	●	●	●	●	●	●	●	●	●	●	●



ROOFING ACCESSORIES

	TESTA DI MORO	RAL 7016	RAL 7037	RAL 9005	RAL 9006	RAL 9010	TESTA DI MORO 3D	RAL 7016 3D	RAL 7037 3D	CORTEX 3D	DOLOMITES GREY	GRAPHITE BLACK	SLATE GREY	AGATE GREY	COPPER ROOF	GREEN ROOF	GREY ROOF	GOLD	
 <p>RETOUCHING PAINT</p>	•	•	•					•	•	•	•	•	•	•	•	•	•	•	
 <p>TAPED SCREWS IN GALVANISED STEEL 4X25 mm</p>	•	•	•	•	•	•	•	•	•	•	•	•	•	•	•	•	•	•	•
 <p>TAPED SCREWS IN STAINLESS STEEL 4X25 mm</p>	•	•	•	•	•	•	•	•	•	•	•	•	•	•	•	•	•	•	•





IRISH OFFICE
Unit 5C, Grange Avenue,
Baldoyle Industrial Estate,
Dublin D13 F5X8, Ireland

 +353 01 839 11 70
 info@qbm.ie

CAT084 - Rev.4 - FEB2023

Mazzonetto SpA

Z.I. Via A. Ceccon, 10
35010 Loreggia (PD) - Italy

T +39 049.93.226.11

F +39 049.93.226.50

W mazonettometals.com



Mazzonetto S.p.A. reserves the right to make changes on its products
anytime in order to better their quality without prior notice.