



AXTER
Waterproofing Systems

QBM
QUALITY BUILDING MATERIALS

WILOTEKT[®]-PLUS

HOT MELT WATERPROOFING

AXTER.CO.UK



WELCOME TO AXTER

We innovate beyond the ordinary, re-imagine what's possible and endeavour to inspire positive change in the way roofs are designed, waterproofed and used. We waterproof differently.

We are a creative team of waterproofing design and technology specialists that share a passion for innovation. For more than 30 years curiosity has been driving us to deliver excellence to our customers and compelling us to reshape the future of roof waterproofing and sustainable roof design.

We specialise in reinforced bitumen membrane (RBM), hot melt, single ply and cold applied liquid waterproofing systems, complemented by green roof, blue roof, solar PV and multi functional sustainable roof system finishes, that safeguard compatibility and single source responsibility.

Collaborate with Axter, and realise your roof's true potential.

Axter has developed a reputation for innovation and quality strengthened by independent accreditation. We are committed to ensuring compliance with industry codes of practice and aim to continue to be at the forefront of waterproofing and flat roofing technological advancement.

To this end, we contribute to and support development of standardisation through active involvement in European and British standard waterproofing committees. Axter is also a manufacturer member of multiple UK and European trade associations, further demonstrating our commitment to accountability, quality and compliance.

We recognise the importance of independent certification and testing to ensure Axter products and systems conform to the latest performance criteria. We work closely with the British Board of Agrément (BBA), European Organisation for Technical Assessment (EOTA), and many other assessment bodies to achieve independent technical approval, aiding our clients when making product selection and waterproofing specification decisions.



ACCREDITATION



FULHAM WHARF, LONDON

Barratt Developments Plc, Lifschutz
Davidson Sandilands Architects



HOT MELT SYSTEMS

High performance, robust and reliable, hot melt structural waterproofing systems are engineered to exceed the lifetime of the building, and are specifically manufactured to provide durable waterproofing for high traffic roof areas. With the ability to be laid at zero falls, these systems are ideal for inverted roofs, podium decks, terraces, living roofs, car parks and civil engineering structures.

The strength and longevity of our hot melt structural waterproofing systems make them a risk-free waterproofing solution, eliminating future replacement costs and ensuring a leak-free roof for as long as the building stands.

Hot melt systems are chosen for their ease and speed of application and robust fully bonded performance characteristics. They create seamless, monolithic waterproofing, eliminating lap failure and the possibility of water tracking beneath the system. The flexible liquid application of hot melt systems allows for complex detailing to be completed quickly and effectively guaranteeing secure protection across all areas.

Axter has developed unique, innovative, second-generation polymer modified hot melt bitumen compounds that provide tough, seamless, self-healing and flexible waterproofing capable of withstanding construction traffic and heavy duty finishes. Our advanced second-generation hot melt systems provide unrivalled benefits against competitor systems.



CHARACTERISTICS



BOW SCHOOL, LONDON

van Heyningen & Haward Architects

WILOTEKT[®]-PLUS

A unique hot melt structural waterproofing system that has brought innovation to the traditional hot melt waterproofing sector, and was invented to deliver reduced energy consumption, improved durability, faster installation speeds, design flexibility, application versatility and simplicity. Wilotekt-Plus is the original and industry renowned second-generation hot melt structural waterproofing system.

Certified for use on all inverted roofs, podium decks, living roofs, blue roofs and car park decks without requirement for system modification, the Wilotekt-Plus inverted roof system assembly combines a pure polymer modified bitumen compound formulation with pioneering reinforcement mesh and high strength integral protection membrane. This results in a tough, seamless, flexible, self-healing, monolithic waterproofing system, engineered to last the lifetime of the building.



PERFORMANCE

Suitable for new build and roof refurbishment projects, Wilotekt-Plus is accredited for zero fall application on concrete roof slabs and roof decks. Designed to adhere directly to the structure, achieving a full bond and filling all cavities in the surface, Wilotekt-Plus eliminates the ability of water to track beneath the waterproofing system.

Wilotekt-Plus has been independently tested in accordance with the European Organisation for Technical Assessment and awarded ETA-03/0049. It is accepted by all third-party building warranty providers such as the LABC and NHBC, and complies in full with current building regulations and all relevant British and harmonised European standards.

Wilotekt-Plus is intended for installation in protected membrane inverted roof constructions, which incorporate non-combustible surface finishes such as gravel ballast and concrete paving slabs that fully cover the roof waterproofing and insulation system.

When protected by inorganic coverings listed in Annex of Commission Decision 2000/553/EC and/or living roof finishes in accordance with 'Fire Performance of Green Roofs and Walls' published by the former Department of Communities and Local Government (DCLG),

Wilotekt-Plus is classified as unrestricted and deemed to fully satisfy Approved Document B (Fire Safety) of The Building Regulations with no requirement for additional system fire testing.

In accordance with industry good practice, fire safety regulation and the NFRC Safe2Torch guidance document, Wilotekt-Plus does not require naked flame installation techniques. A wide range of flame free detailing options are also available to eliminate fire risk when working in proximity to combustible construction materials.





BENEFITS

- Independently tested and approved for zero fall applications – certificate number ETA 03/0049
- Approved Document B – Fire Safety compliant
- High performance 7mm thick system
- Improved application, faster than traditional hot-melt
- Engineered to last the lifetime of the building
- Seamless monolithic waterproofing with zero tracking
- Solvent-free compound with no on-site curing or limitations of use
- Fully adhered with self-healing properties
- Advanced QA procedure over traditional hot melt systems
- Approved for use beneath a variety of hard and soft landscape finishes
- Immediately trafficable after installation
- Root-resistant without the need for environmentally harmful chemical additives
- Prefabricated detailing to ISO 9001 factory quality standards

A photograph of a modern office building. The building features a prominent glass canopy with a grid of colorful panels in shades of blue, green, and red. Below the canopy, the building's facade is composed of numerous horizontal louvers. The sky is clear and blue. The text is overlaid on the left side of the image.

**HOME OFFICE HEADQUARTERS,
LONDON**

Bouygues UK Ltd, Terry Farrell
& Partners

WILOTEKT-PLUS

Inverted roof system assembly

The Wilotekt-Plus inverted roof system assembly is ideally suited to roofs that are heavily trafficked both during and post construction. In this type of flat roof arrangement, the Wilotekt-Plus structural waterproofing system is protected from mechanical damage, UV degradation and extremes of temperature due to the inverted roof finishes installed on top.

The Wilotekt-Plus inverted roof system assembly has been successfully installed on a wide variety of civic, commercial and residential projects, providing a robust, durable, fully bonded and monolithic structural waterproofing system, certified to last the design life of the structure in which it is incorporated.

35

YEAR GUARANTEE

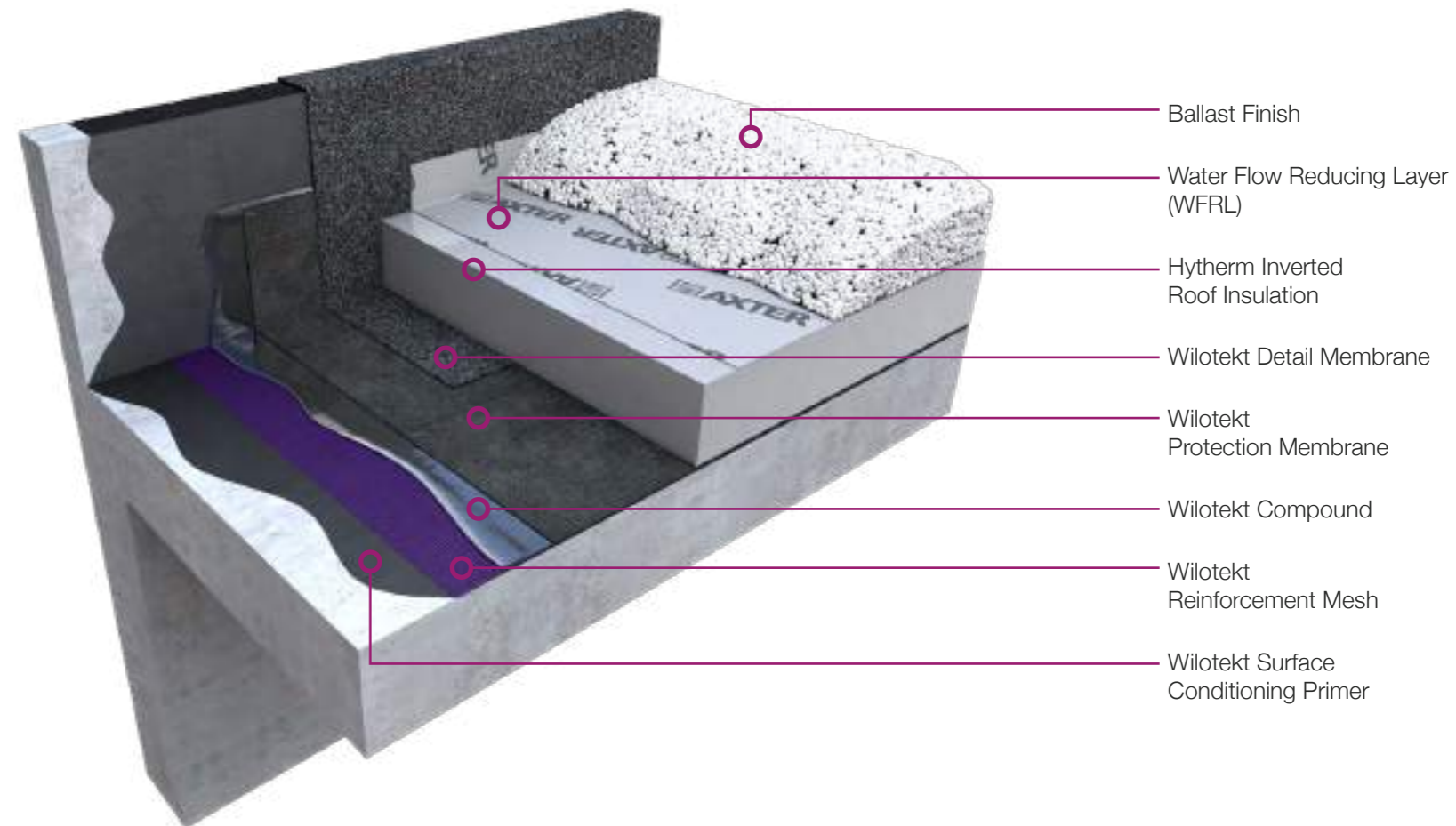

WILOTEKT-PLUS

Roof terrace system assembly

The Wilotekt-Plus inverted roof terrace system assembly transforms a roof into a versatile amenity space suitable for a wide variety of pedestrian uses. Appropriate for both public and private access requirements, Axter's roof terrace finishes are installed above and independent of the structural waterproofing system and will vary depending on client choice and intended use.

Roof terrace finishes commonly comprise of concrete, natural stone or ceramic paving slabs, or modular decking systems elevated off the waterproofing and insulation system by means of a height adjustable support system, providing a free draining and low maintenance surface finish. Separate finishes aid periodic inspection as finishes can easily be lifted and reinstated without compromising the structural waterproofing.

35

YEAR GUARANTEE

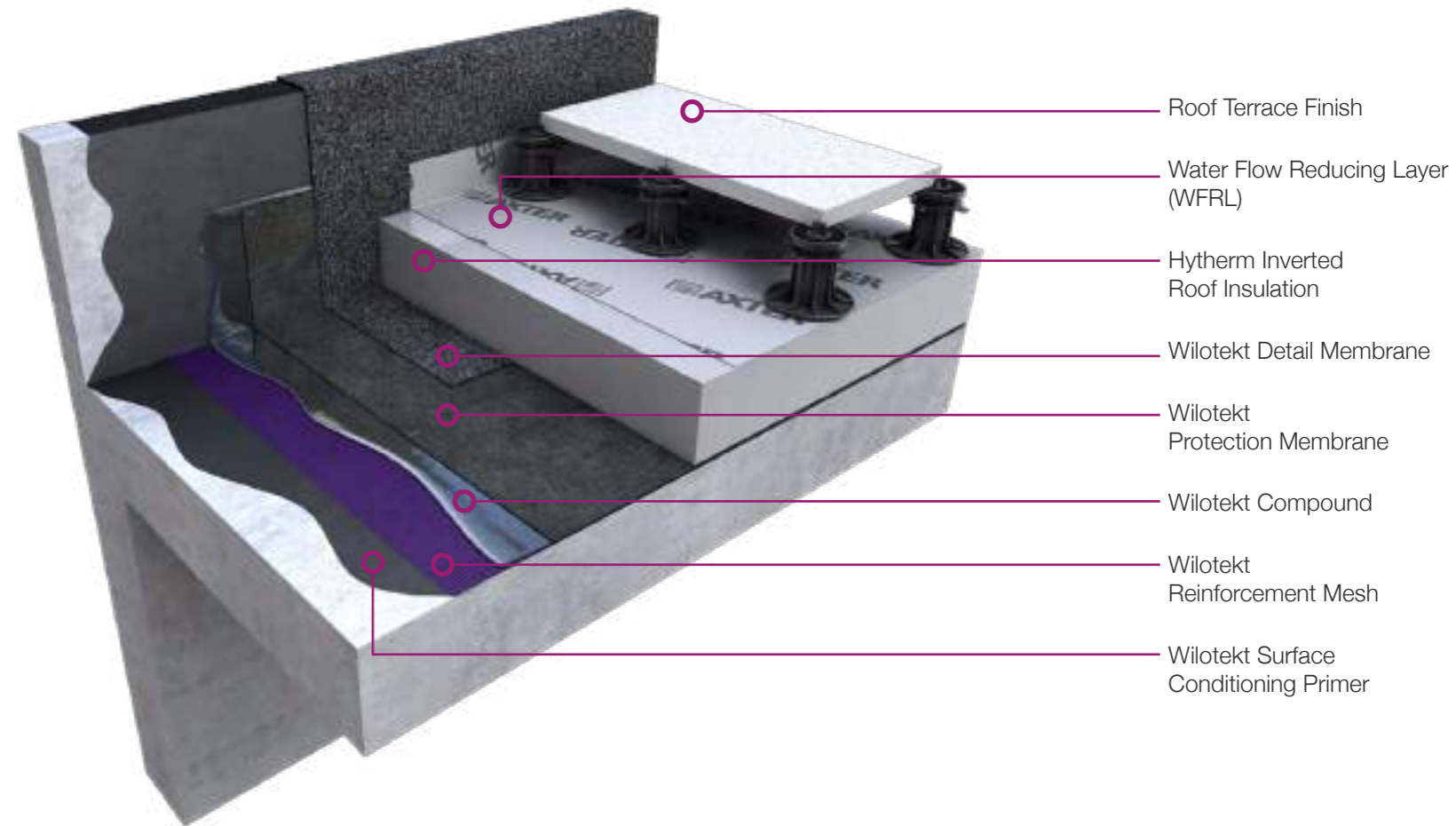

WILOTEKT-PLUS

Podium deck roof system assembly

The Wilotekt-Plus podium deck roof system assembly permits the creation of diverse and multi-functional hard and soft landscaped streetscape environments to be achieved above ground level. Often located above commercial retail space, underground public transport stations, parking garages or residential accommodation, podia are heavily trafficked environments with high load intensive finishes.

The security and long term performance of the Wilotekt-Plus structural waterproofing system is crucial to avoid costly business interruption claims and occupant distress. The Wilotekt-Plus podium deck roof system assembly is renowned as one of the most durable systems in its class, is designed and manufactured to last the lifetime of the building and is the proven choice for protecting high value structures and their contents.

35

YEAR GUARANTEE

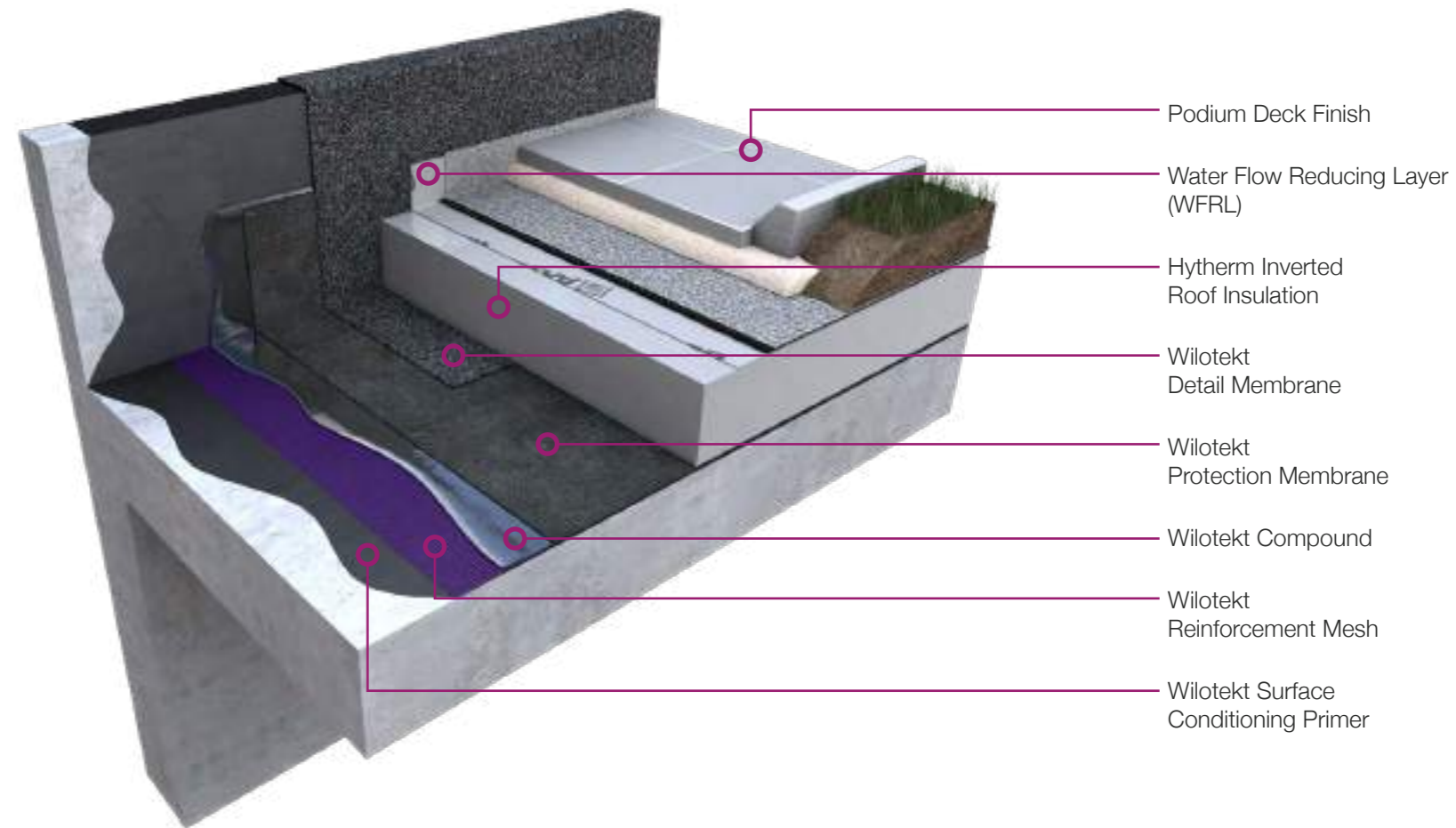

WILOTEKT-PLUS

Living roof system assembly

The Wilotekt-Plus living roof system assembly achieves a seamless, fully bonded, structural waterproofing system that is robust, self-healing and extremely flexible, especially at low temperatures. The Wilotekt-Plus waterproofing system is proven to have excellent durability and has been designed and manufactured to provide an effective barrier to water and water vapour for the design life of the structure.

Wilotekt-Plus has been certified resistant to root penetration without the requirement for environmentally harmful chemical additives and is the ideal waterproofing system for use beneath Axter's wide range of Extensive, Intensive, Biodiverse, Modular and Biosolar living roof systems.

35

YEAR GUARANTEE

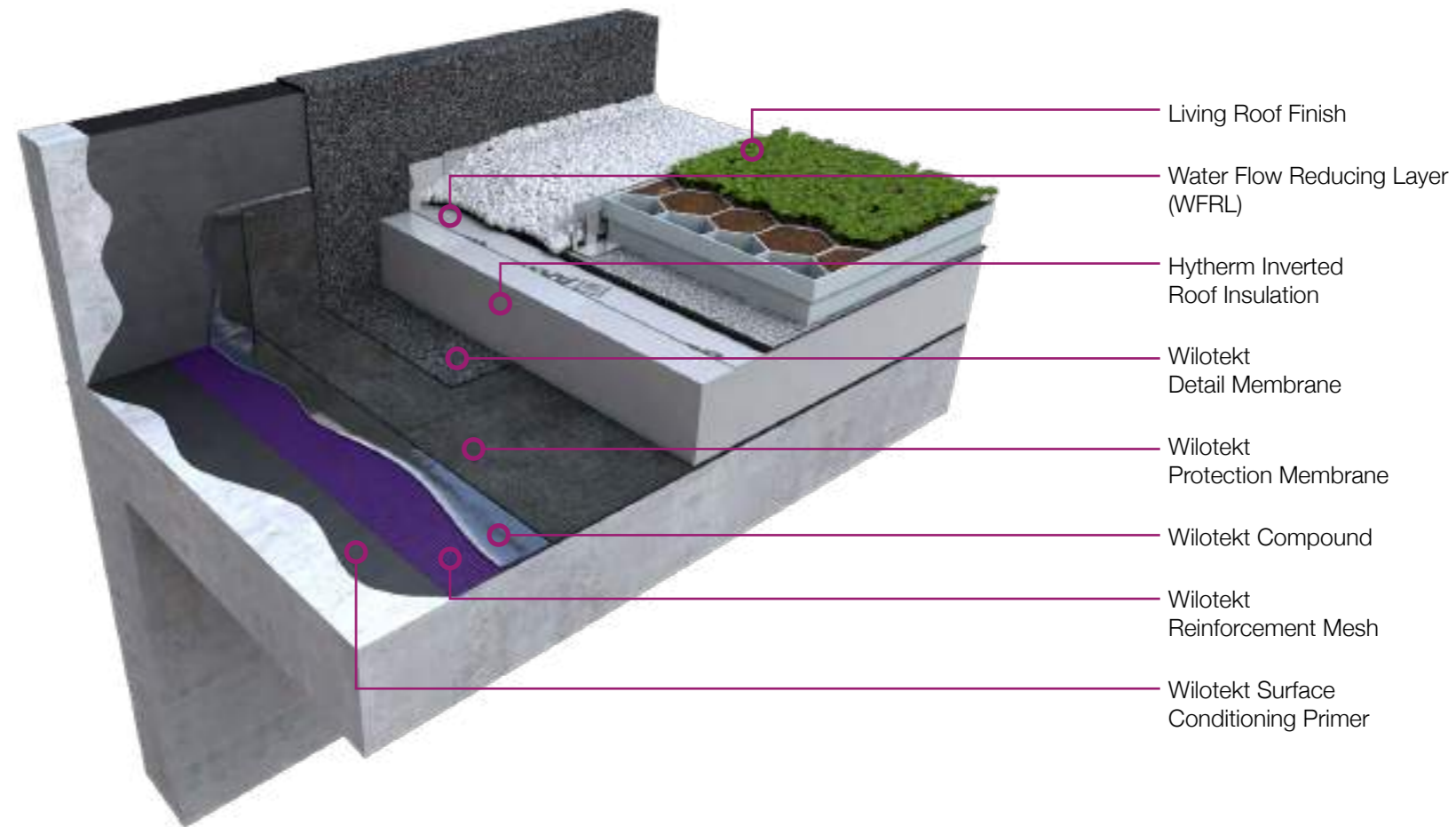

WILOTEKT-PLUS

Blue roof system assembly

The Wilotekt-Plus blue roof system assembly is certified for installation on zero fall roof slabs and decks, and is the ideal structural waterproofing system for use on blue roof specifications in combination with the Aquamodul® geocell stormwater attenuation system.

Its second-generation formulation and innovative method of application eliminates the need for mechanical agitation during melting, and achieves 30% quicker installation speeds than traditional hot melt systems, resulting in an extremely robust and cost effective structural waterproofing system.

35

YEAR GUARANTEE

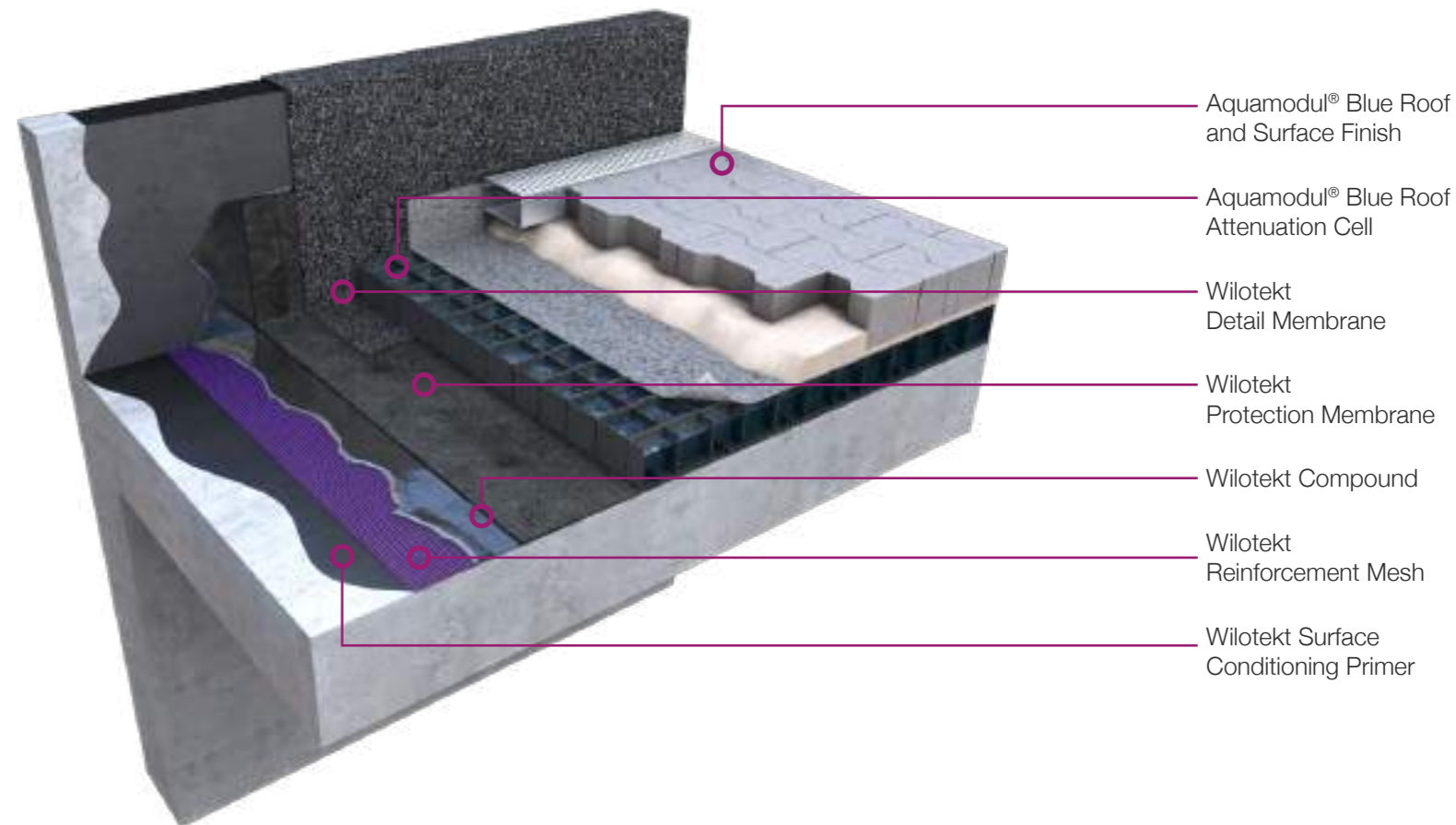

WILOTEKT-PLUS

Parking deck roof system assembly

The Wilotekt-Plus parking deck roof system assembly is designed and certified for use beneath roof top car parks and parking decks. It is suitable for use in combination with a multitude of wearing surface finishes, including hot rolled macadam, ensuring design flexibility.

The Wilotekt-Plus structural waterproofing system achieves a tough yet flexible structural waterproofing barrier designed to last the lifetime of the structure.

35
YEAR GUARANTEE

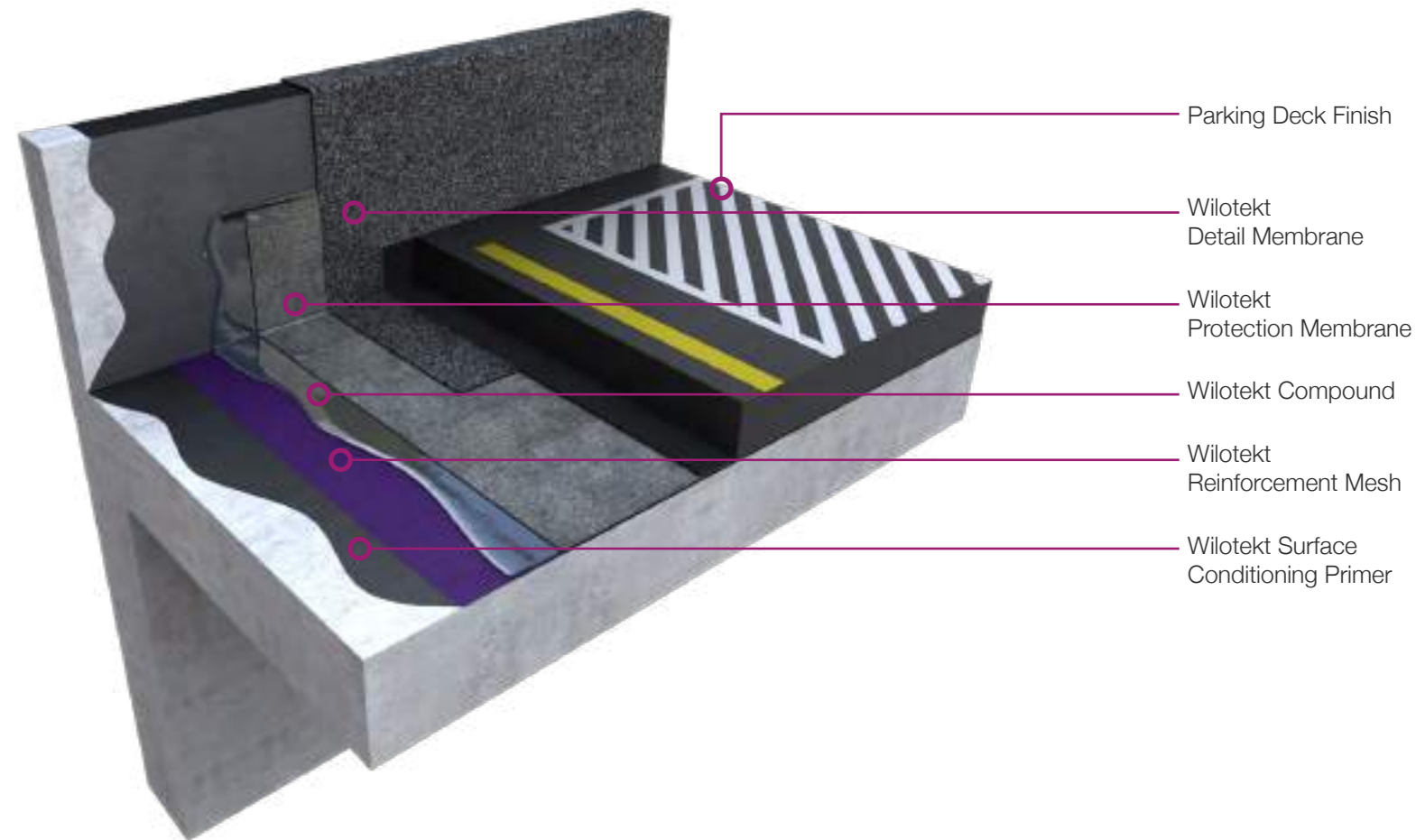



**CITY OF WESTMINSTER
COLLEGE, LONDON**

McClaren Construction Ltd, Schmidt
Hammer Lassen Architects

CITY OF WESTMINSTER COLLEGE

SARAH
SIDE
THE
RE

The simplified Wilotekt-Plus system results in a safer and faster installation without compromising on performance.

It is laid in one easy application, significantly reducing installation times when compared with multi-layer systems. Independent roofing contractor testing has proven Wilotekt-Plus achieves 30% quicker installation speeds over traditional hot melt systems. On site quality control is improved and easy to monitor, once the distinctive purple reinforcing

mesh is fully immersed in the compound and can no longer be seen, the optimal thickness has been achieved.

General detailing is completed using self protected membranes produced in our factory to specific ISO quality and environmental standards. Complex details are completed using pitch pockets to ensure a water-tight performance and a wide variety of inverted roof finishes can then be installed to complete the system.



INSTALLATION



01

PRIME THE STRUCTURE

Brush, roller or spray apply the Wilotekt surface conditioning primer to the prepared, clean and dry structure at a coverage rate of approximately 150-200 g/m² and allow to dry.

02

POSITION THE REINFORCEMENT

Loose lay the purple Wilotekt reinforcement mesh onto the horizontal surfaces of the primed structure, rolled out with minimum 80mm overlaps.

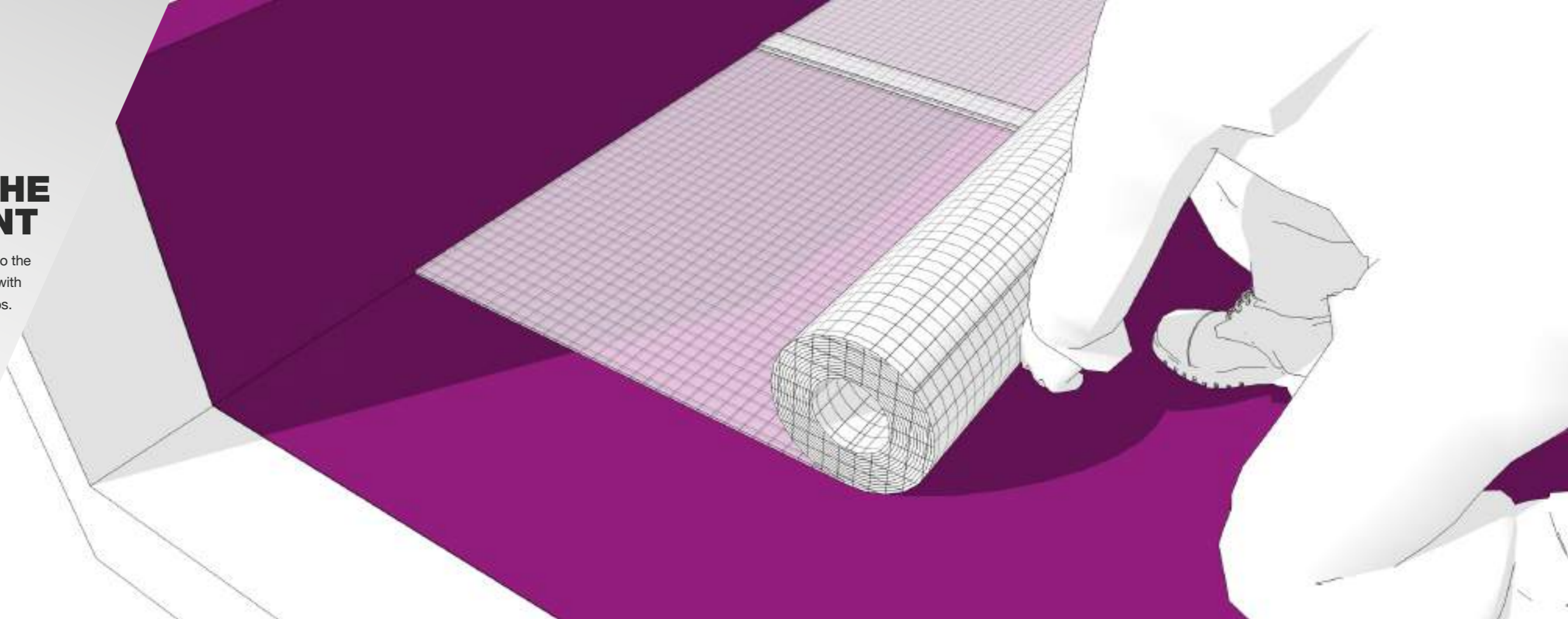



03

INSTALL CORNER REINFORCEMENT

Install prefabricated Wilotekt HDPE internal and external corner reinforcement bonded in molten Wilotekt compound.

04

PREPARE THE COMPOUND

Remove the Wilotekt compound block from its cardboard packaging and set aside for recycling. Place the compound block into a thermostatically controlled bitumen melter, operated by a trained operative.

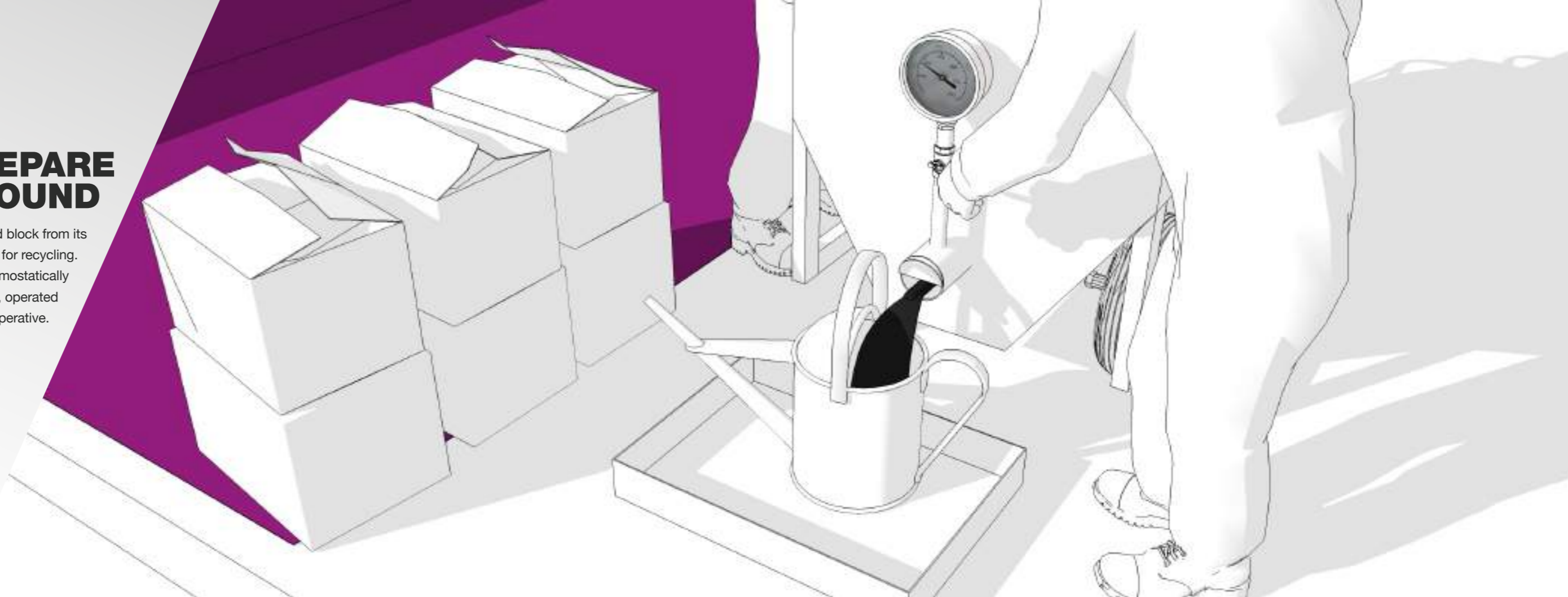

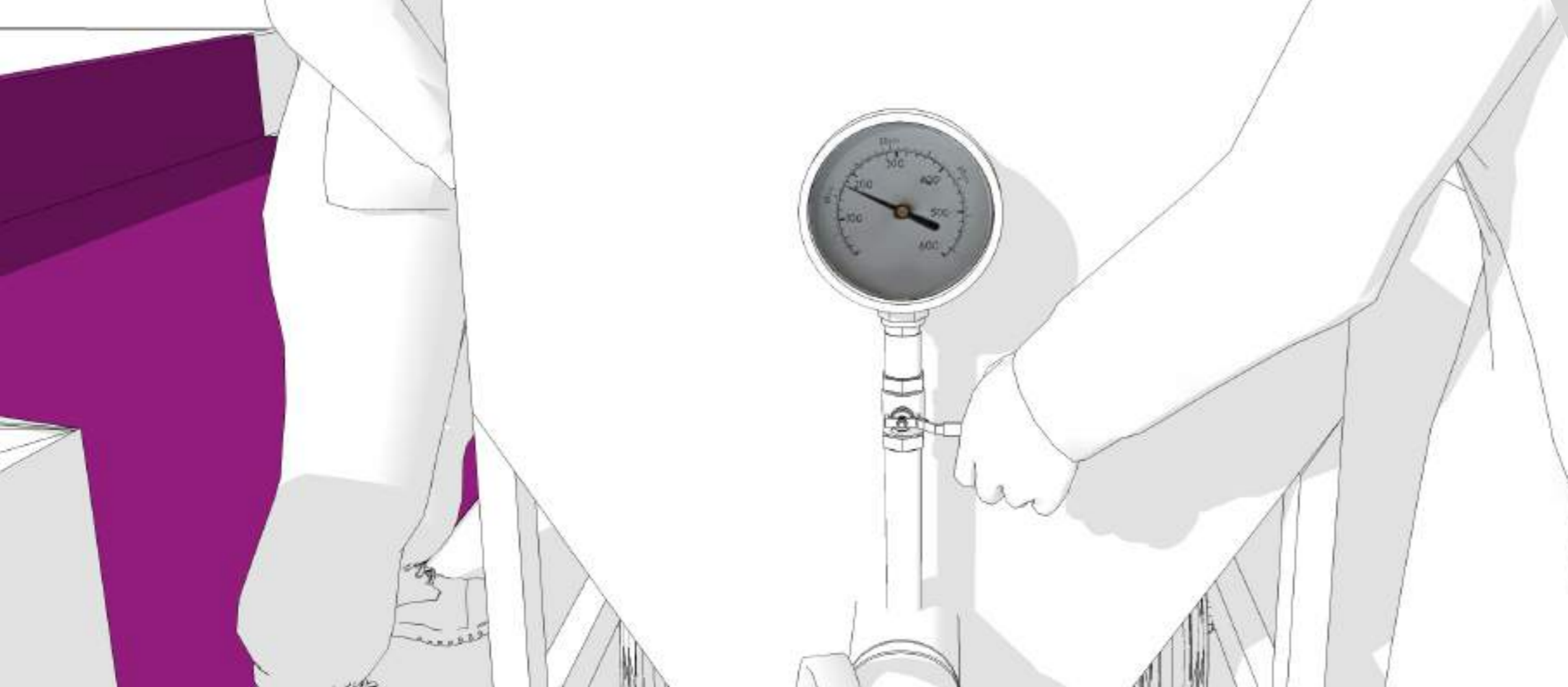

HEAT TO BETWEEN 160°-180°C

Heat the Wilotekt compound to between 160°-180°C in a thermostatically controlled bitumen melter. The temperature should never exceed 200°C. Wilotekt compound does not require agitation during heating.

06

POUR AND ROLL

Pour the Wilotekt compound onto the purple mesh at a coverage rate of 3kg/m^2 , whilst simultaneously unrolling the Wilotekt polymer modified protection membrane.



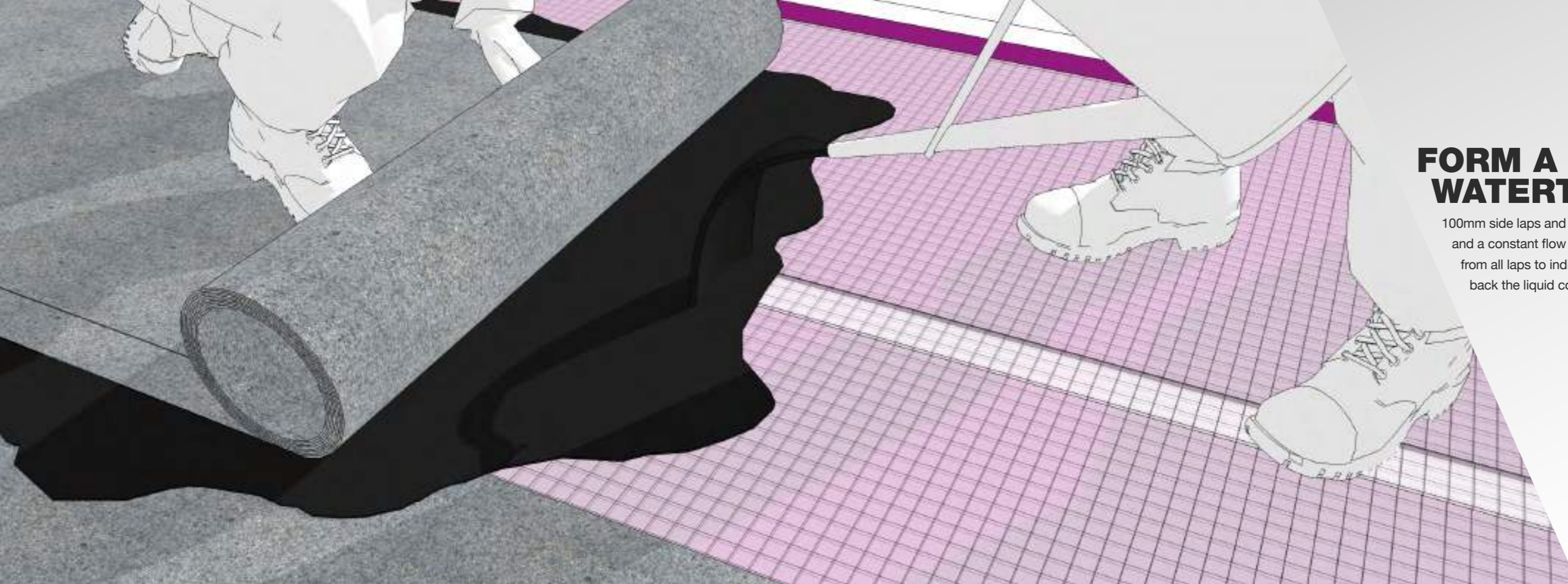

FORM A WATERTIGHT SEAL

100mm side laps and 150mm end laps must be achieved and a constant flow of Wilotekt compound must exude from all laps to indicate a watertight seal. Do not scrape back the liquid compound from the lap.

07

08

SKIRTINGS AND UPSTANDS

Take the Wilotekt protection membrane up all upstands to a maximum height of 150mm, fully bonded in the hot melt compound. Allow excess compound to overspill from the head of the detail.



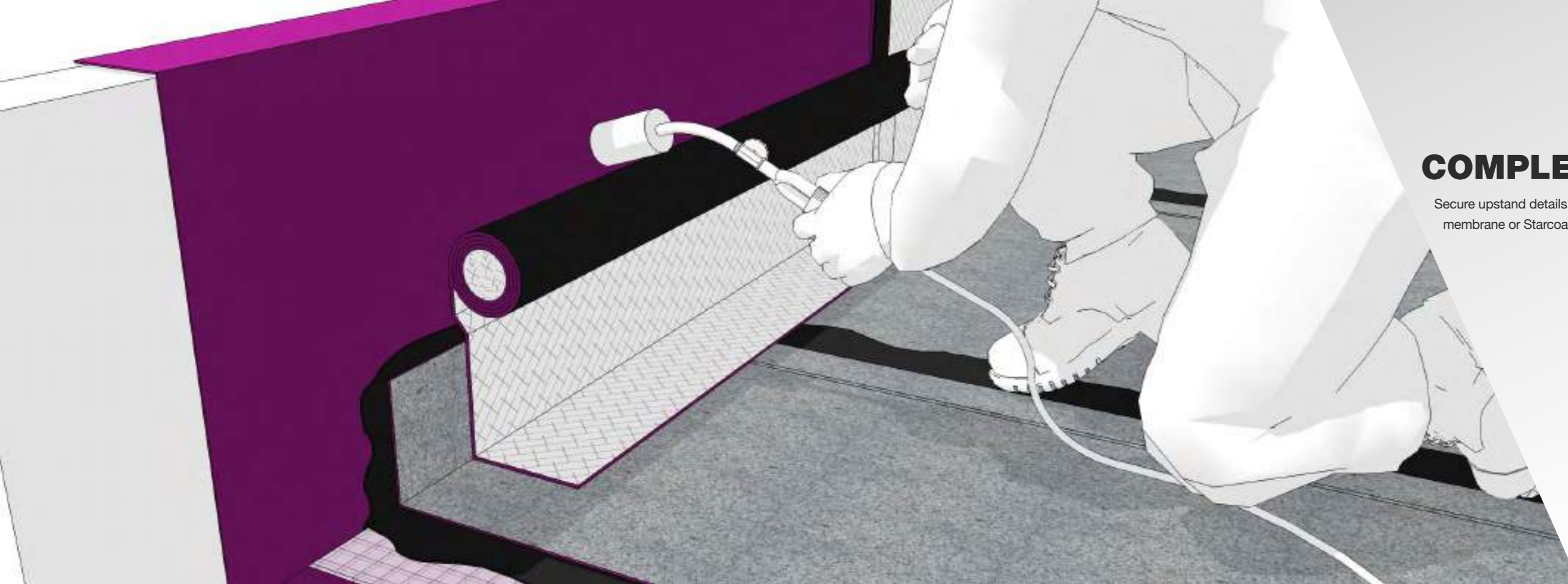

COMPLETE DETAILS

Secure upstand details with the Wilotekt torch-on detail membrane or Starcoat® cold applied flame free liquid membrane.

09

10

INSTALL INVERTED ROOF FINISHES

Install inverted roof finishes comprising thermal insulation, hard and soft landscaping, living/green roofing, blue roofing, ballast, paving slabs, hot or cold rolled macadam, etc.

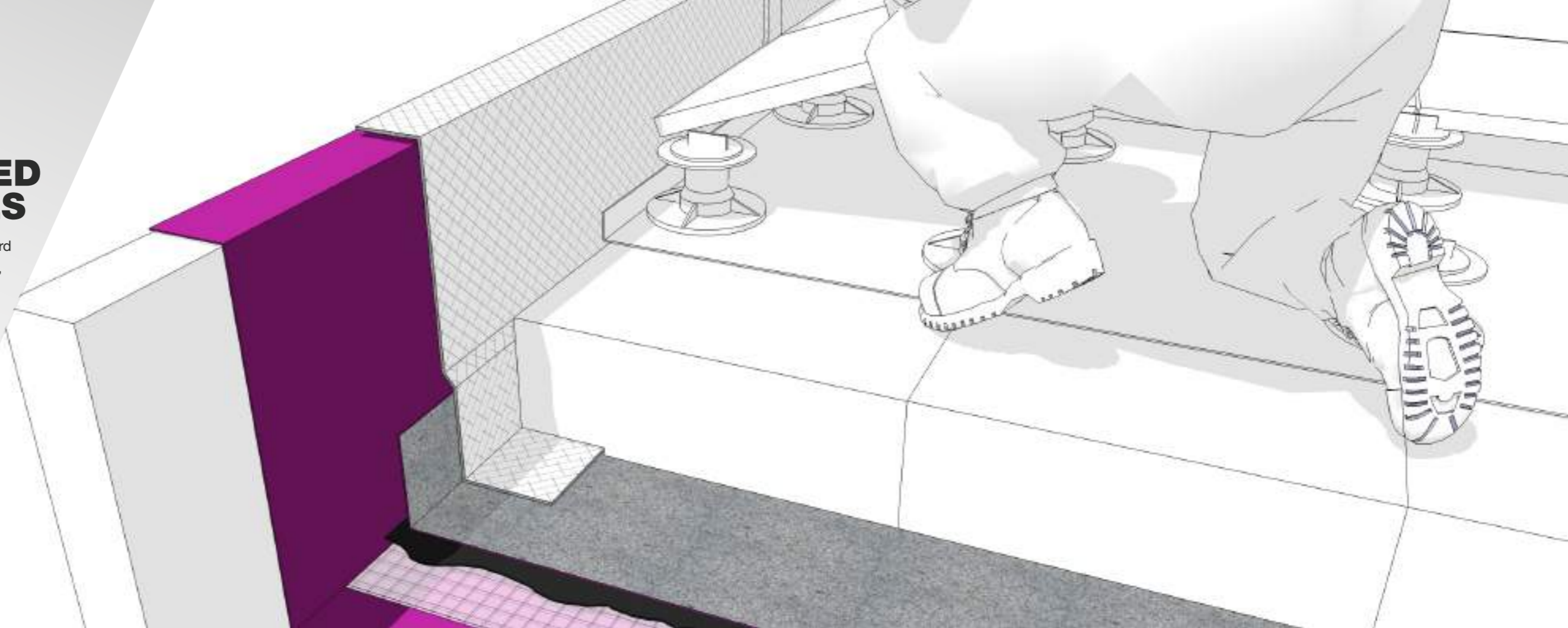



**GOODWOOD RACECOURSE,
CHAMPAGNE BAR**

Hopkins Architects

SYSTEM COMPONENTS

WILOTEKT COMPONENTS

Wilotekt surface conditioning primer

PACKAGING

25lt drums

COVERAGE (APPROXIMATE)

>140m²/drum (depending on substrate condition)

Wilotekt reinforcement mesh

100m x 1m rolls

100m²/roll

Wilotekt compound

26kg block

8.7m²/block

Wilotekt protection membrane

10m x 1m rolls

10m²/roll

Wilotekt-Plus - Table of components

Wilotekt-Plus hot melt structural waterproofing system is assembled from a unique selection of Wilotekt primer, reinforcement mesh, compound and membranes, combined with insulation, accessories and a variety of roof finish components. Please visit www.axter.co.uk/system-components for more technical detail.





CANADA WATER LIBRARY, LONDON
ISG Ipswich, CZWG Architects

Axter Ltd



West Road,
Ransomes Europark,
Ipswich, Suffolk IP3 9SX

axter.co.uk

T: 01473 724056
E: info@axterltd.co.uk
Registered in England No. 1446923



IRISH OFFICE
Unit 5C, Grange Avenue,
Baldoyle Industrial Estate,
Dublin D13 F5X8, Ireland

 +353 01 839 11 70
 info@qbm.ie

DISCLAIMER

NOTE: The information contained within this brochure is provided in good faith by the manufacturer Axter Limited. Whilst every effort has been made to ensure the contents of this document are correct at point of issue, the manufacturer reserves the right to modify product characteristics at any time without notification. Customers are advised to contact Axter Limited directly to obtain the most up to date and current information. Axter Limited cannot accept any liability for misinterpretation of this document and no responsibility will be accepted for incorrect product specification, application and general use where the manufacturer's instructions have not been followed. All products are sold subject to Axter Limited's standard conditions of sales, available upon request.